

RoHS Compliant

| | | | | | | | |
|---|------|--------|-----|---|------------------|---------|------------|
| 4 | REV. | ECN NO | LTR | 5 | DESCRIPTION | REVISER | DATE |
| | A/0 | | | | Initial release. | Wang_jr | 2016.05.05 |

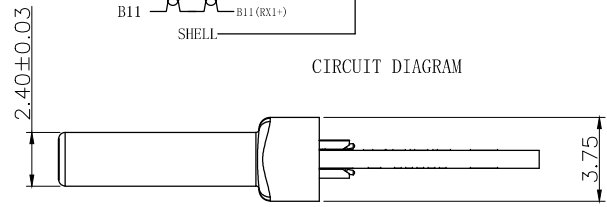

CIRCUIT DIAGRAM

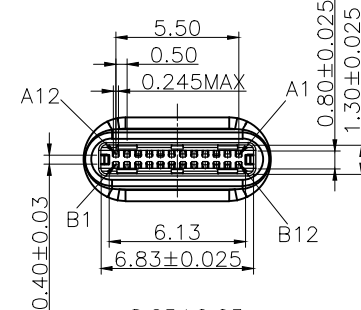
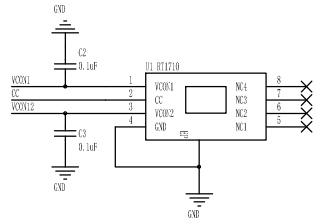
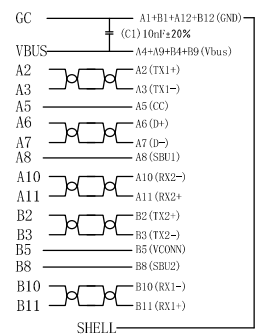
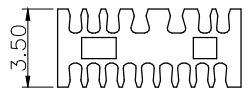
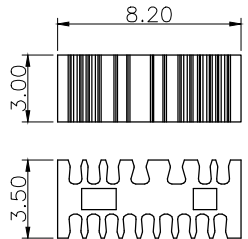
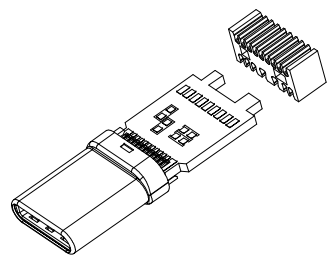
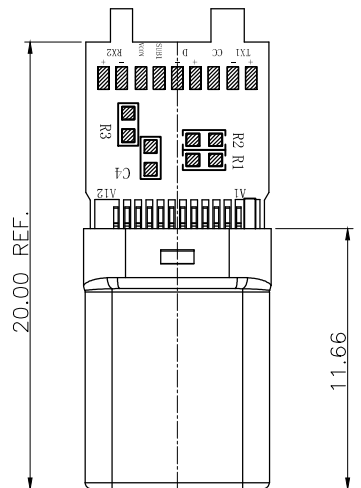
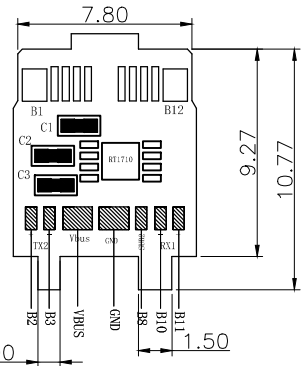
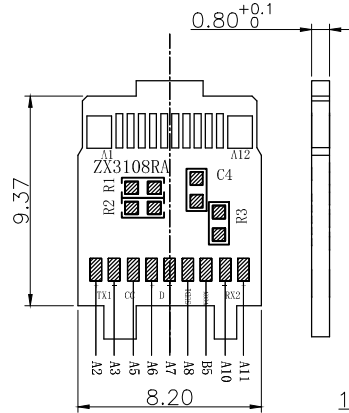
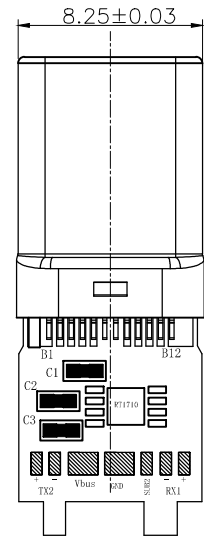

RECOMMENDED PCB LAYOUT TOP VIEW
ALL TOLERANCE ±0.05

| | | | | | | | | | | | |
|-----|------|------|------|-------|----|----|------|------|------|------|-----|
| A12 | A11 | A10 | A9 | A8 | A7 | A6 | A5 | A4 | A3 | A2 | A1 |
| GND | RX2+ | RX2- | Vbus | SBU1 | D- | D+ | CC | Vbus | TX1- | TX1+ | GND |
| GND | TX2+ | TX2- | Vbus | Vconn | | | SBU2 | Vbus | RX1- | RX1+ | GND |
| B1 | B2 | B3 | B4 | B5 | B6 | B7 | B8 | B9 | B10 | B11 | B12 |

NOTES:

- MATERIAL:
 - MOLDING: LCP-E130i ,COLOR:BLACK; UL 94 V=0.
 - CONTACT:COPPER ALLOY 7025 T=0.20mm.
 - SHELL: STAINLESS STEEL SUS 304 T=0.15mm.
 - EMI SHRAPNEL: STAINLESS STEEL SUS 304 T=0.10mm.
 - CARD BUCKLE: STAINLESS STEEL SUS 301 T=0.40mm.
- PLATING:
 - CONTACT:xu" GOLD ON CONTACT AREA,
 - 100u"~200u" MATTE TIN PLATED ON SOLDER TAIL,
 - 50u" Min NICKEL PLATED UNDERPLATED OVERALL.
 - SHELL: 50u" min NICKEL PLATED OVERALL
 - LATCH: 20u" min NICKEL PLATED OVERALL
- MECHANICAL:
 - INSERTION: 5~20N.
 - EXTRACTION: 8~20N.AFTER DURABILITY: 6~20N
 - DURABILITY: 10000 CYCLES AT RATE 200 CYCLES/H
- ELECTRICAL:
 - CURRENT: 5A Max FOR VBUS;1.25A FOR OTHER PIN
 - VOLTAGE: 5VAC
 - WITHSTANDING VOLTAGE: 100V AC.
 - CONTACT RESISTANCE: 40mΩ MAX.
 - INSULATION RESISTANCE: 100MΩ MIN.
- OPERATION TEMPERATURE
 - TEMPERATURE RANGE -40°C ~ +80°C
- ENVIRONMENTAL PROTECTION:
 - RoHS/REACH/加州65/PAHS/红磷/锑/PFSO
- PART NUMBER INFORMATION
 - 319CM-K-A5-X-SN

REV

- Material of shell: SN: SUS With Nickel plating
- Terminal plating:
 - 1: Gold Au 1u" on contact area.
 - 4: Gold Au 15u" on contact area.
 - 6: 2u"GOLD OVER Pd-Ni 30u" ON CONTACT AREA

| | | | | | |
|---------------|--------------|----------------------------|-----|--|---|
| 图号 (DWG NO) | G-319-S1-244 | 单位 (UNIT): | MM | 显赫电子科技有限公司 XianHe Electronic Technology co., ,ltd. | |
| 模号 (MODEL NO) | | 比例 (SCALE) | 1:1 | | |
| 版次 (REV): | A/0 | 页次 (PAGE): | 1/1 | TEL:0769-89138899 FAX:0769-89100950 | |
| 设计 (DESIGN) | Wang_jr | 未注公差 TOLERANCE UNSPECIFIED | | 品名 (ITEM NO) | USB C TYPE TO USB C TYPE 3.1 REV W E-MARKED |
| 审核 (CHECKED) | | X.X ± 0.38 | | 料号 (PART NO) | 319CM-K-A5-X-SN |
| 核准 (APPROVED) | | X.XX ± 0.20 | | | |
| | | X.XXX ± 0.10 | | | |
| | | X' ± 5 | | | |
| | | X.X' ± Z | | | |